

# ANYLOAD®

# 815TS

LED INDUSTRIAL WEIGHING  
INDICATOR



# TECHNICAL MANUAL

Version 21.23

<b>1.</b>	<b>Introduction.....</b>	<b>2</b>
1.1	Main Features.....	2
1.2	Technical Specifications.....	3
<b>2.</b>	<b>Introduction.....</b>	<b>4</b>
2.1	Safety Precautions .....	4
2.2	Main Enclosure.....	5
2.3	Opening Enclosure.....	7
2.4	Mounting Enclosure.....	7
<b>3.</b>	<b>Wiring .....</b>	<b>8</b>
3.1	Controller Board Terminals .....	8
3.2	Electrical Power Wiring .....	9
3.3	Load Cell Wiring.....	10
3.4	Serial Communication Wiring.....	11
3.5	Output Relay Wiring .....	12
<b>4.</b>	<b>Configuration.....</b>	<b>13</b>
4.1	Indicator Setup Menu .....	13
4.2	Indicator Operating Modes .....	13
4.3	Indicator Display Lights .....	14
4.4	Indicator Membrane Keypad .....	15
4.5	F1 Formats .....	19
4.6	F2 Configuration.....	20
4.7	F3 Calibration .....	21
4.8	F4 Filtering.....	22
4.9	F5 Communications .....	23
4.10	F6 Auxiliaries.....	24
<b>5.</b>	<b>Calibration.....</b>	<b>25</b>
5.1	Zero Calibration .....	26
5.2	Span Calibration.....	26
<b>6.</b>	<b>Sealing.....</b>	<b>27</b>
6.1	Physical Sealing.....	27
6.2	Electronic Sealing.....	27
<b>7.</b>	<b>Auxiliaries .....</b>	<b>28</b>
7.1	Peak Mode .....	28
7.2	Count Mode.....	29
7.3	Set Point.....	30
7.4	Serial Protocols .....	31
7.5	Serial Commands.....	32
7.6	Ticket Printing.....	33
<b>8.</b>	<b>Troubleshooting .....</b>	<b>34</b>
8.1	Controller Board .....	34
8.2	Error Codes .....	35
8.3	Jumper Setting .....	35
8.4	Diagnostic Lights.....	36
8.5	Advance Diagnostic.....	36

**I. ABOUT THIS MANUAL**

Thank you for choosing Anyload 815TS industrial LED weight Indicator. This 815TS technical manual provides installation, setup, operation, and configuration information for the 815TS industrial LED Indicators. This manual is intended to be used by trained service technicians and installers. It is recommended to go through the manual in details before installing, operating or configuring the instrument. For further information please contact Anyload Weigh & Measure Inc. authorized dealer.

**II. DISCLAIMER**



Information in this Technical Manual is subject to change without notice due to correction or enhancement. The information described in this manual is the property of Anyload Weigh & Measure Inc. All other brand or product names within this publication are trademarks or registered trademarks of their respective companies. All information contained within this publication is, to the best of our knowledge, complete and accurate at the time of publication.

**ANYLOAD**<sup>®</sup> is a registered trademark of Anyload Weigh & Measure Inc. Copyright © 2023 Anyload Weigh & Measure Inc. All rights reserved.

**III. SAFETY**

Standard safety practices are required before conducting any installation, maintenance, or procedure on device. It is recommended to read and understand the instructions and warnings in this manual before performing any procedure on device. Failure to follow the instructions and warnings could result in injury or death.

Definition of the safety symbols is described in table below.

Symbol	Description
	<b><i>WARNING!</i></b> Indicates a potentially hazardous situation which may result in serious injury or death Indicates a potentially dangerous procedure which may cause injury or death
	<b><i>CAUTION!</i></b> Indicates a potentially wrong procedure which may result in damage to device Indicates a potentially wrong procedure which may result in loss of warranty
	<b><i>NOTICE!</i></b> Indicates a procedure which may need more instructions Indicates a procedure which has more information available

# 1. INTRODUCTION

## 1.1 MAIN FEATURES

- Six digits 0.8” seven segments LED industrial weight indicator.
- Standard seven segments with capability to display alphanumerical characters.
- Indication of up to four units of lb, kg, oz, and gr.
- Indication of gross, net, and tare.
- Indication of stability, and center of zero.
- Indication of auxiliary functions of peak mode, parts count, and set points.
- Up to one million internal counts accuracy with 24bits resolution.
- Auxiliary functions for peak mode, set point, and piece counting.
- Password protected setup and calibration menu.
- Physical and electronic sealing with audit trail function.
- Four or six wires load cells at 0-19mV.
- Up to eight 350R or sixteen 700R load cells with 5V excitation.
- Advance analogue, average, and digital filtering for better stability.
- Two independent RS232 port for streaming and printing.
- One independent RS485 port for industrial networking.
- Remote display master / slave mode.
- Remote command mode via serial communications.
- Remote commands via auxiliary functions.
- Two form C relays operate as set points.
- Standard desk mount bracket.
- Weatherproof stainless steel NEMA 4/IP65 enclosure.
- UL approved encapsulated multi sense voltage internal power supply.
- Breather ventilation to avoid condensation inside enclosure.
- Designed and developed by Anyload Weigh & Measure Inc. in Canada.

Item	Approvals	Description
	UL/cUL	Class II UL / cUL Approved Internal Multi Sense Power Supply, LPS, CB, CE
	NTEP	NTEP USA Class III/IIL 10,000d
	MC	Measurement Canada Class III/IIIHD 10,000d/20,000d
	CE	LVD and ECD 2014/35/EU and 2014/30/EU Directives

## 1.2 TECHNICAL SPECIFICATIONS

The technical specifications of 815TS indicators are as follows:

Item	Specification	Description
1	Display Digits	0.8" (20mm) height, 6 digits, 7 segments
2	Digit Segments	15mcd high intensity brightness red LED
3	Micro Controller	50MHz ARM Cortex M® processor
4	Units Indication	4 units annunciators for lb, kg, oz, g, and optional Ton
5	Status Indication	4 status annunciators for stability, center of zero, gross, and net
6	Membrane Keypad	5 keys domed membrane keypad with buzzer indication
7	Decimal Point	4 decimal point places
8	Communication Ports	3 independent serial ports for RS232, and RS485
9	Communication Baud	1200,2400,4800,9600,19200, 38400 baud rates
10	Excitation Voltage	5V to supply 8 X 350R or 16 X 700R load cells
11	Input Range	0-19mV
12	Measurement Speed	10-80 samples / sec
13	Internal Accuracy	1,000,000 internal counts with 24bits ADC
14	Internal Filtering	3 levels include analogue, digital, and display filtering
15	Digital Output	2 form C relay output rated at 2A / 60VDC
16	Main Enclosure	Stainless steel NEMA 4 / IP65 weatherproof
17	Power Supply	Input: 100-240VAC, 0.5A, 50/60Hz / Output: 12VDC, 2.0A, 25W
18	Power Consumption	120VAC @ 0.1A / 12VDC @ 0.5A (10W AC / 5W DC) typical
19	Operating Temperature	-10°F to 120°F (-10°C to 50°C)
20	Operating Humidity	20%RH to 90%RH
21	Enclosure Ventilation	GORE® breather vent to avoid condensation
22	Physical Dimensions	9.1" W X 7.4" H X 3.0" D (231mm X 188mm X 76mm) includes base
23	Total Weight	2.0kg (4lb) main unit and base, approximately
24	Industry Approvals	UL approved internal universal power supply, LPS, CE
25	Regulatory Approvals	NTEP / MC approvals, and CE marking



## 2. INTRODUCTION

### 2.1 SAFETY PRECAUTIONS

Please practice safety before conducting any installation, maintenance, or procedure on device.

- ✓ The 815TS indicators are pre-wired AC devices with multi sense voltage.
- ✓ It is necessary to practice safety checks before any installation or maintenance.
- ✓ Do not operate this device unless all instructions in this manual have been read.
- ✓ All installation and maintenance shall be conducted by trained service technicians.
- ✓ Avoid any alteration or changes to the device other than factory provided options.
- ✓ Disconnect power source before any installation or maintenance.
- ✓ Make sure proper grounding is provided at the site.
- ✓ Make sure device is properly grounded if custom wiring is provided.
- ✓ Make sure site structure can bear weight of the indicator.
- ✓ Make sure enough clearance is available around the device for accessibility.
- ✓ Make sure all warning signs are visible and not damaged or altered.
- ✓ Follow warning and caution notes in this manual.



Symbol	Description
	<p><b>WARNING!</b></p> <p>Make sure the power source is disconnected before any installation                      Make sure the site has proper grounding</p>
	<p><b>CAUTION!</b></p> <p>Any unauthorized change or alteration in default wiring may void warranty                      Any installation and wiring must be handled by authorized personnel</p>
	<p><b>NOTICE!</b></p> <p>Refer to the local electrical code for the wiring color codes                      Refer to the installation section for instructions to how to access to the wiring terminals</p>

## 2.2 MAIN ENCLOSURE

The main enclosure of the 815TS is a stainless-steel metal enclosure protected by eight screws on the back for easy service. The enclosure is a weatherproof stainless steel with standard desk mount bracket included in the package. All internal parts are installed and mounted inside of the enclosure.

To open the enclosure, there are eight screws located on the back cover to be opened.

The dimensions provided are determined in mm (inches).

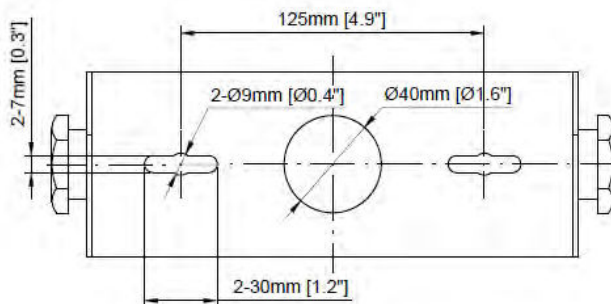
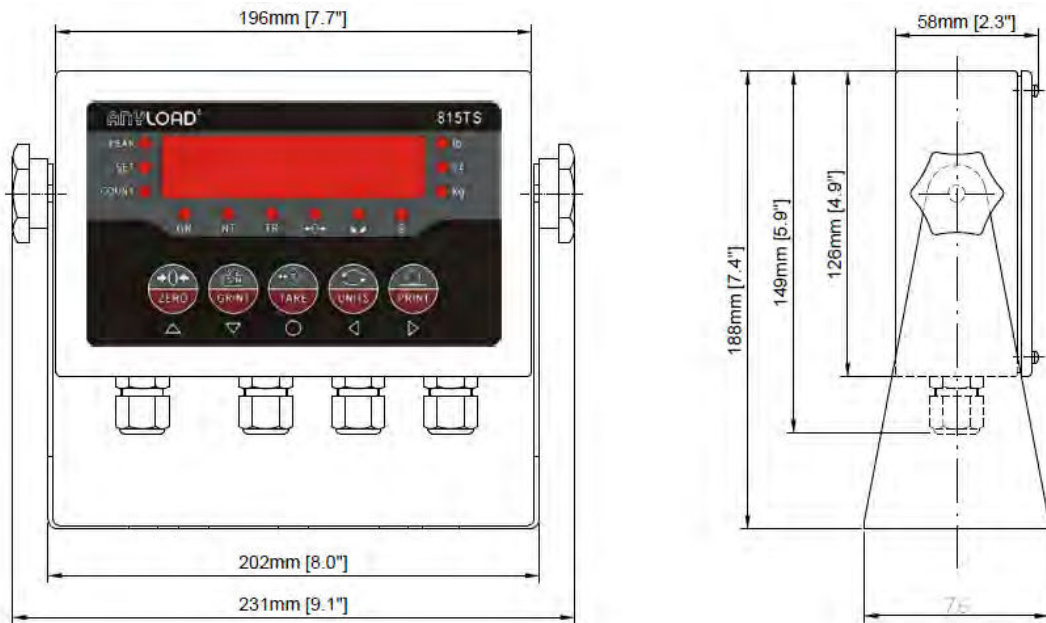

Symbol	Description
	<p><b>NOTICE!</b></p> <p>Make sure device is properly grounded if custom wiring is provided.                      Make sure site structure can bear weight of the indicator.                      Make sure enough clearance is available around the device for accessibility.</p>

The 815TS indicators are consisted of following mechanical parts.

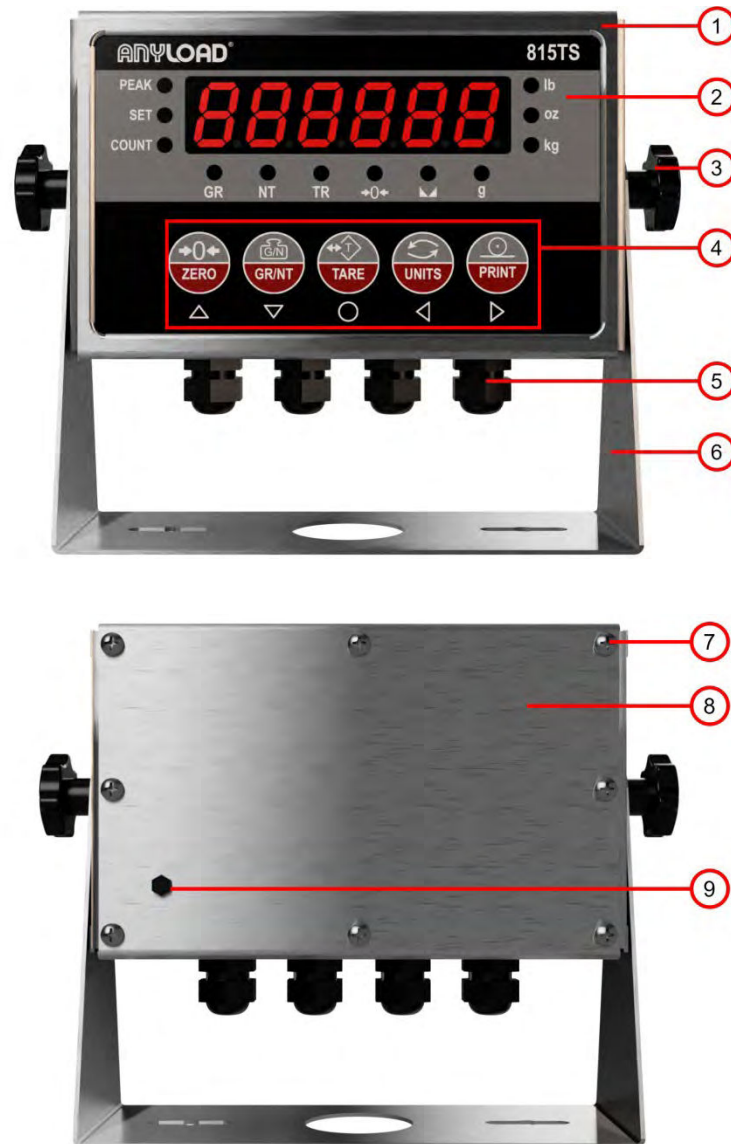

Item	Title	Description
1	Enclosure	Main body of stainless steel
2	Display	Seven segments display with annunciators
3	Knob	Two knobs on the side
4	Keypad	Five buttons membrane keypad
5	Gland	Four strain reliefs for cables
6	Base	Mounting bracket
7	Seal	Special screw for physical sealing
8	Cover	Back cover
9	Vent	Breather ventilation



### 2.3 OPENING ENCLOSURE

To open the cover, loosen eight screws on the back cover of the enclosure and flip down the back cover.

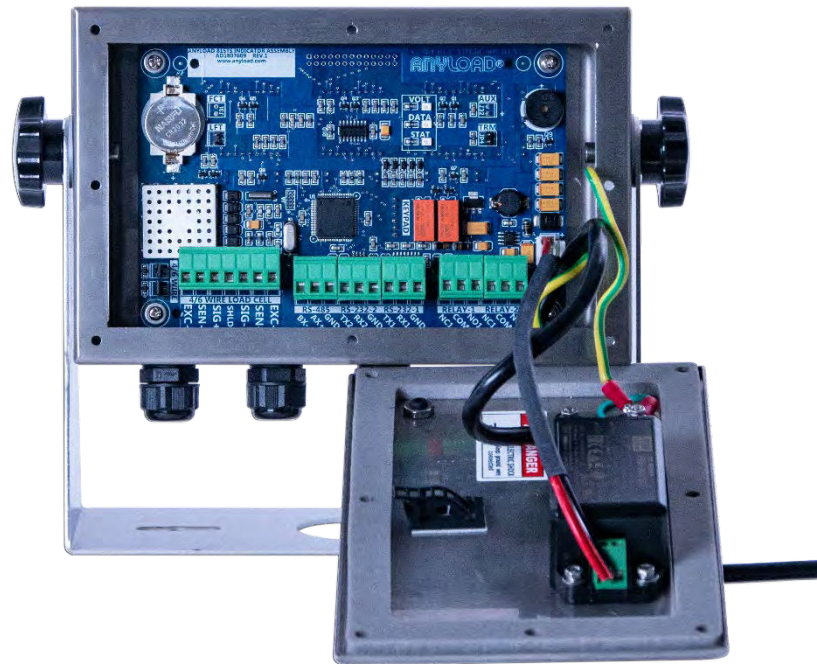

### 2.4 MOUNTING ENCLOSURE

The 815TS indicators may be mounted on the desk with standard desk mount bracket provided in the package.



### 3. WIRING

#### 3.1 CONTROLLER BOARD TERMINALS

All communication signals, load cell inputs, and relay outputs can be terminated to the controller board via accessible screw terminals. These terminals are designed to accept serial data communication signals, 4/6 wire load cell inputs, and two relay outputs.

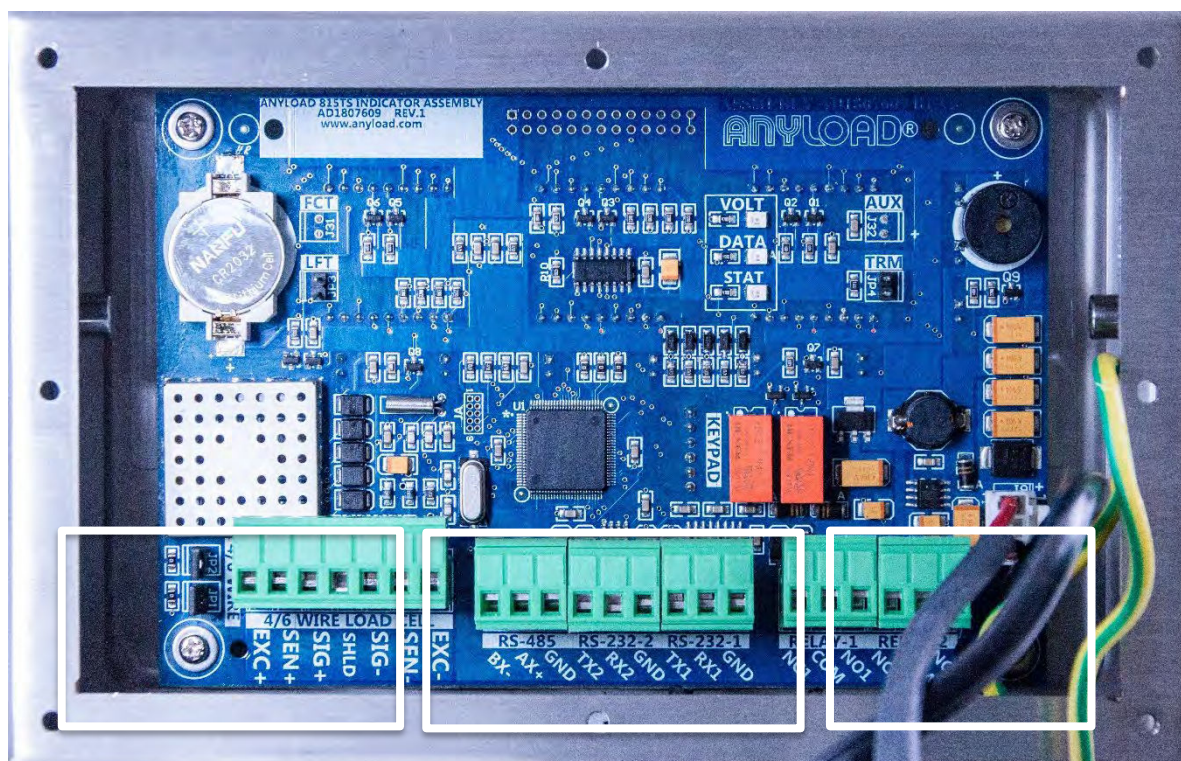



Port	Terminal	Description
1	Load cell	Can be connected to 4/6 wire load cells
2	Communication	Three independent ports provide RS232-1, RS232-2, and RS485
3	Relay	Two form C relays for set points RELAY1 and RELAY2

Symbol	Description
	<p><b>NOTICE!</b></p> <p>Availability of the options is subject to confirmation by manufacturer and may vary by firmware version                      Refer to the configuration section for instructions on how to configure the functions of indicator                      Refer to the installation section for instructions on how to access the wiring terminals</p>



### 3.2 ELECTRICAL POWER WIRING

The 815TS indicators are pre-wired AC devices with regional power cable cord installed via strain reliefs. The proper grounding is provided as default. The standard 815TS indicators do not have any ON / OFF power switch. Therefore, before any installations, make sure all power sources are disconnected.

It is required to use a ground fault circuit interrupter to supply AC lines to the device at the site to avoid any risk or hazard. For the applications requiring custom wiring, all safety precautions and proper grounding must be considered. This table is based on color codes commonly used in North America. For other regions, the local codes must be obtained and observed.

Power Cord		Power Supply	
Wire	Color	Color	Wire
Neutral	White	Red	12V
Live	Black	Black	GND
	Green	Yellow	

Item	AC Supply	Description
1	Input	AC 100-240V~ 0.5A 50-60HZ
2	Output	DC 12V 2A 25W
3	Enclosure	Encapsulated IP67
4	Protection	Short circuit, Overload, Over voltage
5	Approval	Class II UL / cUL approved, with CB CE

Symbol	Description
	<b>WARNING!</b> Make sure the power source is disconnected before any installation Make sure the site has proper grounding
	<b>CAUTION!</b> Any unauthorized change or alteration in default wiring may void warranty Any installation and wiring must be handled by authorized personnel
	<b>NOTICE!</b> Refer to the local electrical code for the wiring color codes Refer to the installation section for instructions to how to access to the wiring terminals

### 3.3 LOAD CELL WIRING

The 815TS indicators provide industry standard screw terminal ports with shield wire installation via screw terminals. The load cell wires coming from the cell to the indicator shall be entered to the unit via bottom strain reliefs and be terminated to the proper terminals. Both kinds of load cells with four and six wires can be connected to the indicator via load cell terminal. The 4/6 wire jumpers can be set accordingly based on the load cell type. For 4 wires load cells the jumpers must be closed.

The load cell cable shield must be terminated to the shield terminal.

	Signals	Loadcell	Indicator	Description
Positive	Excitation+	<b>EXC+</b>		Positive Excitation to the Load Cell
	Sense +	<b>SEN+</b>		Positive Sense to the Load Cell
	Signal +	<b>SIG+</b>		Positive Signal from the Load cell
Earth Ground	Shield	<b>SHLD</b>		Load Cell Shield Wire
Negative	Signal -	<b>SIG-</b>		Negative Signal from the Load Cell
	Sense -	<b>SEN-</b>		Negative Sense to the Load Cell
	Excitation -	<b>EXC-</b>		Negative Excitation to the Load Cell



Symbol	Description
	<b>WARNING!</b> Make sure the power source is disconnected before any installation Make sure the site has proper grounding and shielded earth wire
	<b>CAUTION!</b> Any unauthorized change or alteration in default wiring may void warranty Any installation and wiring must be handled by authorized personnel
	<b>NOTICE!</b> Refer to the configuration section for instructions to how to calibrate the scale Refer to the installation section for instructions to how to access to the wiring terminals

### 3.4 SERIAL COMMUNICATION WIRING

The 815TS indicators provide industry standard screw terminal ports with shield wire installation via screw terminals. The ports are automatically detected and adjusted upon start up. There are three communication ports available as RS232-1, RS232-2, and RS485. The serial communication wires coming to the indicator shall be entered to the unit via bottom strain reliefs and be terminated to the proper terminals.

Communication	Indicator	Peripherals	Description
<b>Protocol</b>	RS-232	RS-232	Function
	GND	GND	Signal Ground
<b>RS-232-1 Stream Port</b>	RX1	TXD	Streaming Port Receive Data
	TX1	RXD	Streaming Port Transmit Data
	GND	GND	Signal Ground
<b>RS-232-2 Printer Port</b>	RX2	TXD	Printer Port Receive Data
	TX2	RXD	Printer Port Transmit Data

Communication	Indicator	Peripheral	Description	
<b>Protocol</b>	RS-485	RS-485	RS-485	Function
<b>RS-485 Communication</b>	GND	GND	GND	Signal Ground
	AX +	TRX +	TR/RX +	Positive Transmit and Receive
<b>Full or Half</b>	BX -	TRX -	TR/RX -	Negative Transmit and Receive

Symbol	Description
	<b>WARNING!</b> The use of RS232 is limited to 15m(50ft), and RS485 to 300m(1000ft) Make sure the site has proper grounding
	<b>CAUTION!</b> Any unauthorized change or alteration in default wiring may void warranty Any installation and wiring must be handled by authorized personnel
	<b>NOTICE!</b> Refer to the configuration section F5 for instructions to how to configure inputs and outputs Refer to the installation section for instructions to how to access to the wiring terminals

### 3.5 OUTPUT RELAY WIRING

The Relay 1 and Relay 2 can be used to control the outputs as set points to control different peripherals. Both relays are form C relays supporting NC/NO functionality. The use of relay contacts is limited to a DC voltage of 60VDC.

The set point relays are disabled as default. They can be set accordingly inside the setup menu.

Output	Mode	Description
Relay 1	N/C1	Setpoint 1 Normally closed
	COM1	Common for voltage or ground
	N/O1	Setpoint 1 Normally closed

Output	Mode	Description
Relay 2	N/C2	Setpoint 2 Normally closed
	COM2	Common for voltage or ground
	N/O2	Setpoint 2 Normally closed

For setpoint activation, setup menu utilities must be activated.







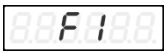
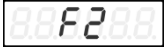

The setpoints also can activate the beep sound if the buzzer is set.

Symbol	Description
	<b>WARNING!</b> The relay contact is limited to 2A/60VDC Make sure the site has proper grounding
	<b>CAUTION!</b> Any unauthorized change or alteration in default wiring may void warranty Any installation and wiring must be handled by authorized personnel
	<b>NOTICE!</b> The relay functions are disabled as default Refer to the auxiliary section F6 of setup menu for instructions to how to configure outputs

## 4. CONFIGURATION

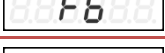
### 4.1 INDICATOR SETUP MENU

The function setup menu is consisted of different function blocks used to set different configuration values of 815TS indicators. There are six function blocks currently available for configuration showed in the table below. Entering into the setup menu is protected by a password for legal for trade applications. Any changes in setup menu values will result incrementing the audit trail.

Block	Menu	Description
	<b>FORMAT</b>	Functions Related to Scale Formats
	<b>CONFIG</b>	Functions Related to Scale Configuration
	<b>CALIBRATION</b>	Functions Related to Scale Calibration
	<b>FILTERING</b>	Functions Related to Scale Filtering
	<b>COMPORT</b>	Functions Related to Communication Ports
	<b>AUXILIARY</b>	Functions Related to Auxiliaries
	<b>UTILITIES</b>	Functions Related to Utilities
	-	N/A
	<b>DIAGNOSTIC</b>	Advance Diagnostics

### 4.2 INDICATOR OPERATING MODES

The 815TS indicators can be used in three different modes.

Mode	Description
<b>Weigh Mode</b>	Normal weight mode: Normal weighing in legal for trade or none legal for trade applications Refer to F1, F2, and F3 for calibration.
<b>Peak Mode</b>	Peak mode function: Peak mode function in none legal for trade applications Refer to F6 for configuration.
<b>Count Mode</b>	Piece count function: Piece counting function in none legal for trade applications Refer to F6 for configuration.

### 4.3 INDICATOR DISPLAY LIGHTS

The 815TS indicators provide twelve LED annunciators for different functions and operation listed below.

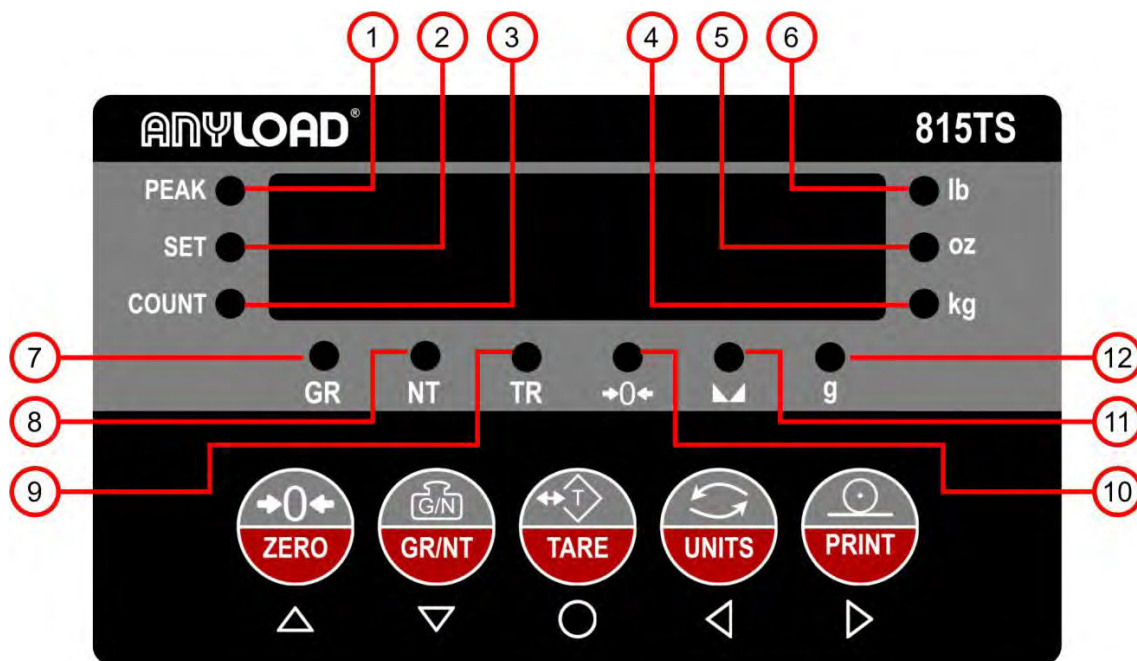

Legend	LED	Function	Description
1, 2, 3	PEAK/SET/COUNT	Peak / Set/ Count indication	Auxiliary functions blinking or solid
4	kg	kg unit indication	Kilograms
5	oz	oz unit indication	Ounces
6	lb	lb unit indication	Pounds
7	GR	Gross indication	Gross weight is displayed
8	NT	Net indication	Net weight is displayed
9	TR	Tare indication	Tare value is acquired
10	→0←	Zero indication	Center of zero
11	M	Stability indication	Scale reading is stable
12	g	g unit indication	Grams



### 4.4 INDICATOR MEMBRANE KEYPAD

The 815TS setup menu is used to calibrate the scale and configure main operating functions of the 815TS indicators. A five keys membrane keypad, located at front panel of the enclosure, is used to provide basic functions of the indicator enter into, exit from, and navigate through setup menu functions as well. The 815TS setup menu is protected by password and electronics sealing for Legal or Trade (LFT) applications.



To enter into setup menu, press and hold **ZERO** & **TARE** keys together for two seconds.  
To exit from setup menu, use the same keys combination.



To navigate through menus, press short or hold **UNITS** or **PRINT** keys (LEFT or RIGHT).



To enter into or exit from a sub menu press **TARE** key (ENTER/ACCEPT).



To change a sub menu value, press **ZERO** or **GR/NT** keys (UP or DOWN).



To change a value in an editor menu, press **ZERO** or **GR/NT** keys (UP or DOWN).



To change a digit in an editor menu, press **UNITS** or **PRINT** keys (LEFT or RIGHT).

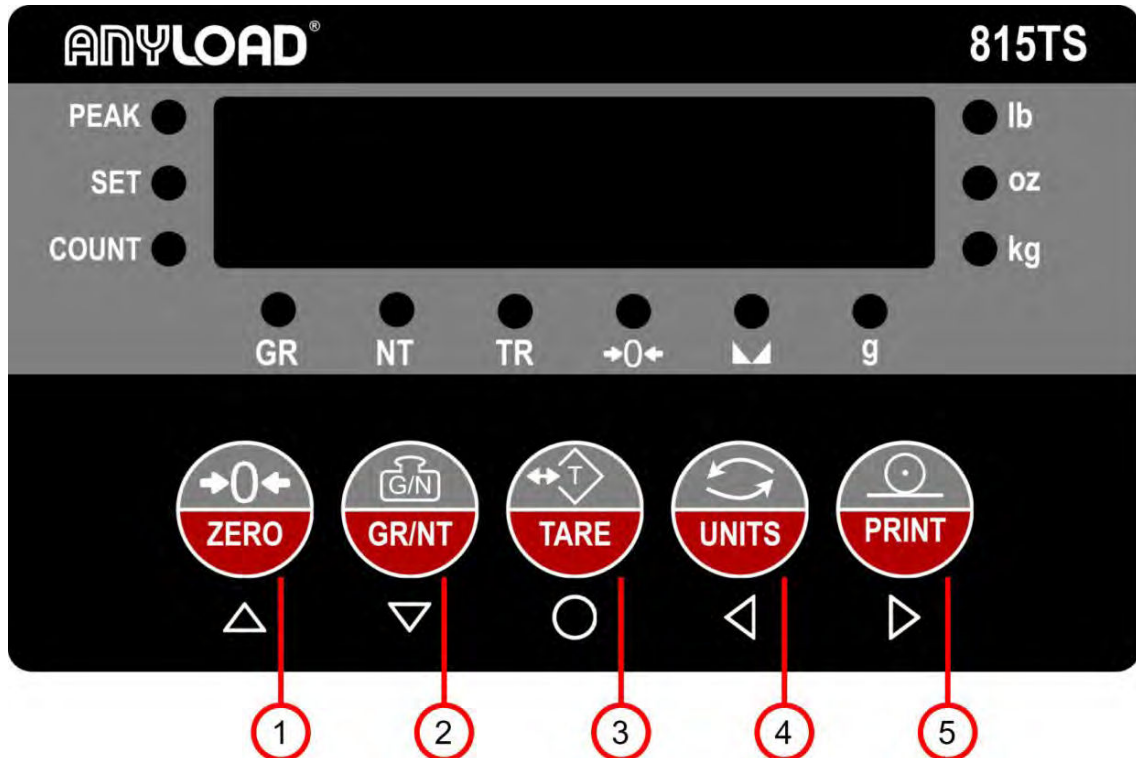







The 815TS keypad basic and alternative operations are listed in below table.

The keypad is used for basic functions, entering setup menu, entering audit function, and editing values.



Keypad	Primary	Alternate	Description
	Zero	 Up	Weight Mode: Zero Scale Setup Menu: Change the value increasing Editor: Change the value increasing
	Gross / Net Clear	 Down	Weight Mode: Switch gross/net. Long press clears tare. Editor: Change the value decreasing
	Tare	 Enter	Weight Mode: Tare Scale Setup Menu: Enters a sub menu function. Editor: Enter / Accept value
	Units Clock	 Left	Weight Mode: Switches units. Long press set clock. Setup Menu: LEFT navigation through F menu Editor: Change the digit number to left
	Print	 Right	Weight Mode: Prints a string or ticket. Setup Menu: RIGHT navigation through F menu Editor: Change digit number to right
	N/A	  Enter / Exit Setup	Pressing ZERO and TARE together will enter setup A password is required to enter setup menu Use editor to enter password ( -0001- default ) Use same keys to exit from setup menu
	N/A	  Enter Audit	Pressing PRINT and TARE together will enter audit trail. The audit trail switches between CFG and CAL Display shows CFG.000 / CAL,000 momentarily Use GR/NT key to exit

• *ENTERING INTO SETUP MENU*

Press and hold  &  keys together simultaneously for two seconds to enter setup menu, the SETUP message will appear. A password is required to enter into setup menu. Use  or  to change the value of the digit. Use  or  to change the digit to right or left. Press  when the correct password is entered. Then first function block F1.0 will be displayed.



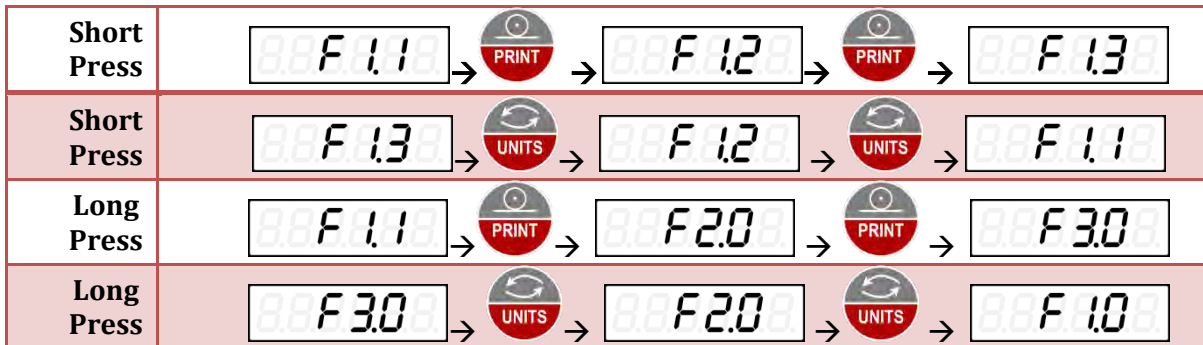

• *NAVIGATING THROUGH MENU*

To navigate through the menu, press  or  keys. A short press will cause FX.X to increase or decrease by 0.1 (move within the submenu) and a long press will increase or decrease by 1 (exit the submenu and go to the root menu).



• *EDITING SUBMENU VALUES*

Press  key to enter the shown submenu and the current setting of that submenu will be displayed. Press  or  keys to change the value of the submenu as required.

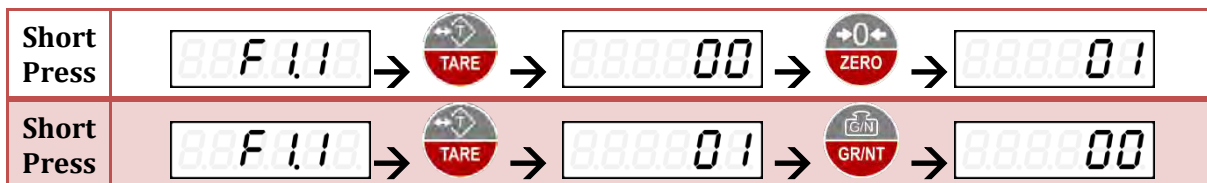



- *SETTING SUBMENU VALUE*

Press  key to accept the selected value and return to the submenu. A FX.X message showing corresponding function block will be displayed.







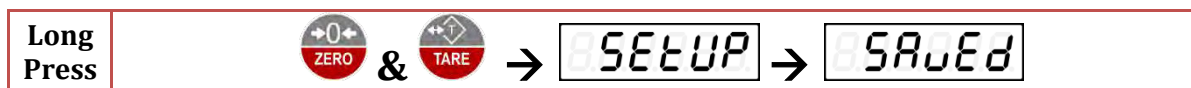

- *EXITING FROM SETUP MENU*

Press and hold  &  keys together simultaneously to save and exit the setup menu. A SAVED message will be displayed and then it will reset. To exit without saving, press and hold TARE button.









- *EDITING NUMERIC VALUE*

Press  key to enter the shown submenu and the current setting of that submenu. If a numeric value is displayed, use  or  to change value of the digit. Use  or  to change the digit to right or left. Press  when the desired value is entered.



- *CHANGING TIME DATE*

Press and hold  key to enter the time / date edit mode. This function is disabled as default. Use  or  to change the value of the digit. Use  or  to change the digit to right or left. Press  when the desired password is entered. Then first function block F1.0 will be displayed.

### 4.5 F1 FORMATS

Function related to divisions, decimals, units, and capacity formats of the scale.

Function	Value	Setting	Description
F1.1 Grad Size	<b>1d</b>	<b>1d</b>	Scale divisions.
	2d	2d	It sets the minimum display resolution.
	5d	5d	To be set before calibration.
	10d	10d	
	20d	20d	
	50d	50d	
	100d	100d	
	200d	200d	
F1.2 Decimal Point	<b>None</b>	<b>None</b>	Scale decimals.
	0.0	0.0	It sets the decimal points.
	0.00	0.00	To be set before calibration.
	0.000	0.000	
	0.0000	0.0000	
F1.3 Calibration Unit	<b>1</b>	<b>kg</b>	Calibration Unit.
	2	lb	The unit used to calibrate the scale. To be set before calibration.
F1.4 Power up Unit	<b>1</b>	<b>kg</b>	Power up primary unit.
	2	lb	Scale power up at this unit.
	3	oz	
	4	g	
F1.5 Alternative Unit	0	None	First alternate unit.
	1	kg	
	<b>2</b>	<b>lb</b>	
	3	oz	
	4	g	
F1.6 Alternative Unit	<b>0</b>	<b>None</b>	Second alternate unit.
	1	kg	
	2	lb	
	3	oz	
	4	g	
F1.7 Capacity Setting	<b>005000</b>	<b>005000</b>	Scale capacity.
	000001	000001	It sets the capacity of scale.
	100000	100000	To be set before calibration.
F1.8 Over Capacity	0d	0d	Over capacity.
	1d	1d	It sets the overload based on capacity.
	<b>2d</b>	<b>2d</b>	To be set before calibration.
	9d	9d	
	2pc	2%	
F1.9 Reserved	AUDit	AUDIT	Audit is default to password protected.
	Lft	LFT	LFT if sealed physically to use LFT switch.

## 4.6 F2 CONFIGURATION

Functions related to zero, stability, and tare configuration of the scale.

Function	Value	Setting	Description
F2.0 Zero Range	<b>2pc</b> 5pc 10pc 90pc	<b>2%</b> 5pc 10% 90%	Zero range. Scale can be zeroed within the range of set value. It is set 2% for legal for trade applications
F2.1 Zero Tracking	Off <b>0.5d</b> 1d 2d 3d	Off <b>1/2d</b> 1d 2d 3d	Automatic zero tracking. Scale maintains zero within the set division value.
F2.2 Power up Zero	<b>0</b> 1	<b>Off</b> Active	Power up zero scale. Scale attempt to zero on power up.
F2.3 Stability	Off <b>1d</b> 2d 3d 5d 10d	Off <b>1d</b> 2d 3d 5d 10d	Stability. Scale maintains stability within the set division value.
F2.4 Stability Timer	<b>0.25-5.0s</b>	0.25-5.0s	Stability timer. Each equal to 0.25 sec. Scale returns to stability within the time set.
F2.5 Unstable Blank	<b>0</b> 1	<b>Off</b> Active	Blank Weight. Scale blanks display if the weight is not stable.
F2.6 Tare Regulation	0 1 <b>2</b> 3	None CAN <b>NTEP</b> OIML	Tare Regulations. NONE: Tare can be acquired on any positive weight > 0. Tare can be cleared at any time. NTEP / US: Tare can be acquired on any positive weight > 0. Tare only can be cleared in gross mode at zero. CAN / Measurement Canada: Tare can be acquired only in gross mode weight > 0. Tare only can be cleared in gross mode at zero. OIML / EU: Tare can be acquired on any positive weight > 0. Tare only can be cleared in gross mode at zero.
F2.7 Tare Lock	<b>0</b> 1	<b>Off</b> No Tare	Tare lock. Tare button is disabled if set.
F2.8 Tare Auto	<b>0</b> 1	<b>Off</b> 1	Auto Tare. Acquires tare on positive weight values automatically.
F2.9 Clear Auto	<b>0</b> 1	<b>Off</b> 1	Auto Clear. Clears tare automatically when scale is at zero.

## 4.7 F3 CALIBRATION

Functions related to zero and span calibration of the scale. **Use this with caution!**

Function	Value	Setting	Description
F3.0 Local gravity	Gravity	Off Set	If SET, gravity compensation is in effect. Local gravity to be entered.
F3.1 Zero Scale	Zero Calibration	DEAD   CLEAR SCALE   --CAL4-   DONE	Prompts CLEAR SCALE.  Clear the scale. Press Enter to dead load scale if desired. Press Left if want to abort operation.  Prompts DONE after successful operation. <b>! Section 5 CALIBRATION for more details.</b>
F3.2 Span Scale	Span Calibration	SPAN   LOAD SCALE   005000   --CAL4-   DONE	Prompts LOAD SCALE.  Load scale with test wait and enter value. Press Left if want to abort operation. Press Enter to span scale if desired. Use editor menu to enter proper test weight value. Press Enter to span scale.  Prompts DONE after successful operation. <b>! Section 5 CALIBRATION for more details.</b>
F3.3 Gravity	Gravity		If F3.0 SET, then destination gravity to be entered.
F3.4 Adc Count	A to D	N/A	Displays A/D raw count.
F3.5 Span Edit	000000	000000	Displays current span value to be edited if desired. <b>! Use this with caution. It changes span value.</b>
F3.6 Password Edit	-0001-	-0001-	Edit or change current password. Use editor to change value / digit. <b>! Use this with caution. It changes setup password.</b>
F3.7 Factory Reset	-0001-	-0001-	Asks for password to reset to factory default values. Use editor to enter current password. <b>! Use this with caution. It resets all calibration values.</b>
F3.8 Send		N/A	For service use only.
F3.9 Receive		N/A	For service use only.

## 4.8 F4 FILTERING

Functions related to the filtering.

Function	Value	Setting	Description
F4.0 Filter Preset	1	Light	Filter preset. It will set all filters accordingly for the best stability. It starts with light filtering, ends to the heavy filtering.
	2	2	
	<b>3</b>	<b>Medium</b>	
	4	4	
	5	Heavy	
F4.1 Digital Filter	0.5	Heavy	Digital Filter. Heavy to light.
	1.0	1	
	2.0	2	
	3.0	Light	
F4.2 Average Filter	10	Light	Average Filter.
	50	1	
	75	2	
	100	3	
	150	4	
	200	Heavy	
F4.3 Filter Threshold	2	2	Filter threshold division for the Scale fast response. Higher the number, slower the response.
	4	4	
	8	8	
	12	12	
	14	14	
	18	18	
F4.4 Filter Sense	2	2	Filter sensitivity samples for the scale fast response. Higher the number, less the sensitivity.
	5	5	
	8	8	
	10	10	
	12	12	
	15	15	
F4.5 Display Filter	0	Fast	Display Filter. It sets display update rate in seconds.
	<b>0.25</b>	<b>0.25 sec</b>	
	0.50	0.50 sec	
	0.75	0.75 sec	
	1	Slow	
F4.6 Startup Count	0	0	Startup count down enabled as default. Disabled If set to 1.
	1	1	



**4.9 F5 COMMUNICATIONS**

Functions related to the serial communication ports.

Function	Value	Setting	Description
F5.0 Port1 Baud Rate	1200 2400 4800 <b>9600</b> 19600 38400	1200 2400 4800 <b>9600</b> 19600 38400	RS232-1 baud rate setting
F5.1 Port1 Data Bit	<b>8-None</b> 7-Even 7-Odd	<b>8-None</b> 7-Even 7-Odd	RS232-1 data bits
F5.2 Port1 Mode	0-9 <b>0</b>	0-9 <b>Stream</b>	RS232-1 mode selection 0 streaming standard string 1 send out weight with PRINT key 2 send out simple ticket with PRINT key 3 accept serial commands via serial port 4 send out weight if scale is stable with PRINT key 5 remote display mode 6-9 auxiliary ZPCT
F5.3 Port2 Baud	<b>9600</b>	<b>9600</b>	RS232-2 baud rate setting Same as RS232-1
F5.4 Port2 Data Bit	<b>8-None</b>	<b>8-None</b>	RS232-2 data bits Same as RS232-1
F5.5 Port2 Mode	0-9 <b>1</b>	0-9 <b>Print</b>	RS232-2 mode selection Same as RS232-1
F5.6 Port3 Baud	<b>9600</b>	<b>9600</b>	RS485 baud rate setting Same as RS232-1
F5.7 Port3 Data Bit	<b>8-None</b>	<b>8-None</b>	RS485 data bits Same as RS232-1
F5.8 Port3 Mode	0-5 <b>0</b>	0-5 <b>Stream</b>	RS485 mode selection Same as RS232-1
F5.9 Stream Delay	0 <b>0.25</b> 0.50 0.75 1	0 <b>0.25s</b> 0.50s 0.75s 1 sec	Universal streaming delays for all ports in seconds. It sets the time delay between each streaming string.

### 4.10 F6 AUXILIARIES

Functions related to peak, count, and relay auxiliary functions.

Function	Value	Setting	Description
F6.0 Peak Mode	0 1	Off On	Peak mode activation  <b>! See Section 7 AUXILIARIES for more detail.</b>
F6.1 Peak Value	000000	000000	Peak mode threshold
F6.2 Peak Reset	0 1	Off On	Peak mode automatic reset
F6.3 Peak Delay	0-5.0 0	0-5.0s 0	Peak mode automatic reset delay
F6.4 Count Mode	0 1	Off On	Piece count mode activation  <b>! See Section 7 AUXILIARIES for more detail.</b>
F6.5 Count Average	Put 2 Put 5 Put 10 Put 20 Put 50 Put 100 Put 200	Put 2 Put 5 Put 10 Put 20 Put 50 Put 100 Put 200	Establishes the average piece weight. The editor asks to enter the number of pieces. After adjusting numbers to desired value, Put number of pieces on scale and take average weight. Average weigh will be stored for piece count mode.  If F6.4 is off, it shows COUNT OFF.
F6.6 Set Point	0 1	Off On	Relay set point function activation  <b>! See Section 7 AUXILIARIES for more detail.</b>
F6.7 Set Point 1	000000	000000	Set point 1 threshold Use editor to set the SP1 value
F6.8 Set Point 2	000000	000000	Set point 1 threshold Use editor to set SP2 value
F6.9 Buzzer	0 1 2	Off Key Set	The keypad buzzer can be set on or off. If set 2, works with setpoints respectively.



## 5. CALIBRATION

The 815TS indicators utilize a reliable two point's calibration called dead load (zero calibration), and span scale (span calibration). The calibration is done through two simple sub menus inside the setup menu. The setup menu is protected by a password for the legal for trade applications. The audit trail function also is available to record the calibration and configuration changes.



Function	Value	Setting	Description
F3.1 Zero Scale	Zero Calibration	DEAD   CLEAR SCALE   --CAL4--   DONE	Prompts DEAD / CLEAR - SCALE.  Clear the scale. Press Enter to dead load scale if desired. Press Left if want to abort operation.  Prompts DONE after successful operation.
F3.2 Span Scale	Span Calibration	SPAN   LOAD SCALE   005000   --CAL4--   DONE	Prompts SPAN / LOAD - SCALE.  Load scale with test weight and enter value. Press Left if want to abort operation. Press Enter to span scale if desired. Use editor menu to enter test weight value. Press Enter to span scale.  Prompts DONE after successful operation.











Use  to abort function before is executed.

Symbol	Description
	<b>WARNING!</b> For proper wiring of the load cell refer to wiring section For 4/6 wire load cells the jumpers must be set accordingly on the main board
	<b>CAUTION!</b> The setup menu is protected by password for legal for trade applications The audit trail function CAL, CFG increments by one every time a calibration is performed
	<b>NOTICE!</b> For legal for trade applications the LFT jumper on main board must be open. Refer to the F1, F2, and F3 for instructions to how to configure the scale before calibration





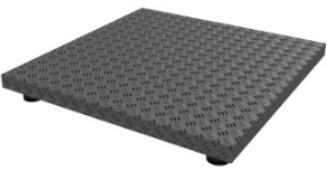







Before performing calibration, all functions related to F1 FORMAT, and F2 CONFIG inside the setup menu may be set accordingly or left at default values. It is recommended to navigate

through F1, and F2 functions before any calibration. Use   for ENTER / ACCEPT.

### 5.1 ZERO CALIBRATION

- Navigate to F3.1 inside setup menu, and press Enter  
- Display shows   
- Clear the scale platform and press Enter   
- Display counts down to zero calibration  
- Display shows DONE at the end.

### 5.2 SPAN CALIBRATION

- Navigate to F3.2 inside setup menu, and press Enter  
- Display shows   
- Load the scale with the test weight, and press Enter   
- Display shows the default test weight value to be edited 
- Using the editor keys, enter desired test weight value and press Enter  
- Display counts down to span calibration  
- Display shows DONE at the end.
- The calibrated weight is displayed with a blinking C, indicating inside the setup menu.

## 6. SEALING

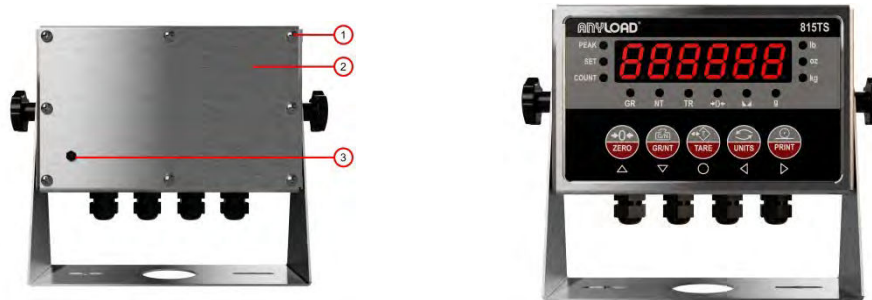

### 6.1 PHYSICAL SEALING

The 815TS indicator can be sealed physically by two special screws provided on the back cover. It can be used as complementary to electronic sealing. The LFT jumper on main board also must be kept open for legal for trade application for password protection of the setup menu.



### 6.2 ELECTRONIC SEALING

The 815TS indicators setup menu is protected by the password. The 815TS indicators therefore can be sealed electronically by using audit trail function. The audit trail can be accessed from front keypad as follows:

Press and hold  &  keys together simultaneously for two seconds to enter audit trail function, the AUDIT message will appear. Then CAL / CFG momentarily will be displayed.

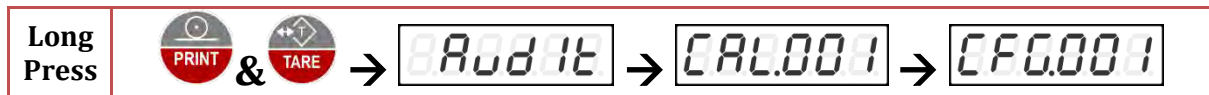

CAL: Increments by one every time a calibration F3 is performed



CFG: Increments by one every time a change in F1, F2, or F3 is performed



Use  CLEAR to exit from audit trail function.

The LFT jumper header on main board must be open in legal for trade applications.

Symbol	Description
	<p><b>NOTICE!</b></p> <p>The indicator is protected by password to enter into setup menu                      Make sure the password is recorded somewhere safe in case is needed                      The CAL/CFG is activated in factory. Therefore, it may not be set to 1 as default</p>

## 7. AUXILIARIES

### 7.1 PEAK MODE

The 815TS can be used to detect and establish peak weights using peak mode. The peak mode can be activated inside setup menu. The peak mode has a threshold value that must be set inside setup menu. There is option of the automatic peak and clear as described in the menu.

A LED on the front panel is used to display and identify peak mode operation.

Function	Value	Setting	Description
F6.0 Peak Mode	0 1	0 1	Peak mode activation
F6.1 Peak Threshold	000000	000000	Peak threshed value
F6.2 Peak Auto	0 1	0 1	Peak automatic clear
F6.3 Peak Delay	0-5.0 0	0-5.0s 0	Peak auto clear delay Each increment equals to 0.25 sec

The PEAK annunciator operates based on below table if the function is enabled.

LED	Function	Description
PEAK	Solid Red	The peak weight is established
PEAK	Blinking ½ Seconds	Normal weigh mode with peak mode activated
PEAK	Off	The peak mode is off

Use  CLEAR long press to clear established peak weight.

Symbol	Description
	<p><b>NOTICE!</b></p> <p>Use GR/NT key long press clears the peak weight The peak mode only used for none legal for trade applications. The minimum peak division is 1d</p>

## 7.2 COUNT MODE

The 815TS indicators utilize a piece counting mode to count number of pieces based on average weight of the piece established in setup menu.

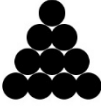
Function	Value	Setting	Control by SW1 and SW2
F6.4 Count Mode	<b>0</b> 1	<b>Disabled</b> Enabled	If set to 0, the piece count is off. If set to 1, the piece count is enabled.
F6.5 Count Average	<b>Put 2</b> Put 5 Put 10 Put 20 Put 50 Put 100 Put 200	<b>Put 2</b> Put 5 Put 10 Put 20 Put 50 Put 100 Put 200	Load Pieces on the scale. Select desired number of pieces. Press Enter to establish average piece weight. If the function is disabled it displays FAIL.  



In normal weight mode, use  key to switch between weight and count mode.  
If in COUNT mode, the communication port also will switch to PC mode and sends out the count.

The COUNT annunciator operates based on below table.

LED	Function	Description
COUNT	Solid Red	Function is enabled. Piece count is displayed
COUNT	Blinking ½ Seconds	Function is enabled. Weight is displayed
COUNT	Off	Function is disabled in setup menu.

Symbol	Description
	<b>NOTICE!</b>  Use UNIT key to switch between piece count and weight mode The piece count is only available in primary calibrated unit for none legal for trade applications The minimum count division is 1d

### 7.3 SET POINT

The 815TS indicators utilize a dual set point function mode to perform different applications such as simple check weighing. The two set point values which indicate the threshold weight can be set inside the setup menu.

Function	Value	Setting	Controlled by Commands
F6.6 Set Point	0 1	Disabled Enabled	Set point function can be enabled or disabled
F6.7 Set Point 1	000000	000000	Edit set point 1 to control RELAY 1
F6.8 Set Point 2	000000	000000	Edit set point 2 to control RELAY 2

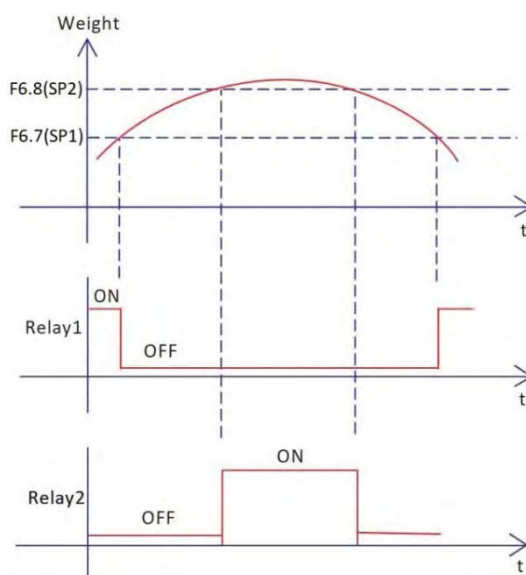

LED	Function	Description
SET	Blinking ½ Seconds	The weight value is greater than SP2
SET	Solid Red	The weight value is between SP1 and SP2
SET	Blinking ½ Seconds	The weight value is less than SP1

Symbol	Description
	<p><b>NOTICE!</b></p> <p>Use of relay contacts is limited to 2A/60VDC                      The set point function can be used to activate a check weighing annunciator                      The minimum threshold weight division is 1d</p>



7.4 SERIAL PROTOCOLS

The standard string format to be transmitted by RS232-1 and RS232-2 of 815TS indicator includes start of the text character, weight numeric values, unit character, status character, and end of the text character. An example of string protocol for single remote display application connected to an indicator is illustrated below.

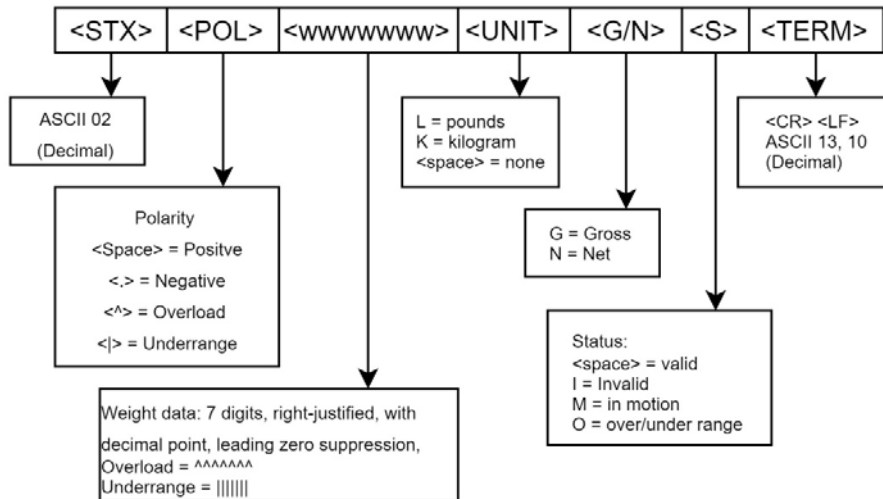

For multi scale and network applications using RS485, there is a similar string format with a dedicated address. This unique address can be set in setup menu. The streaming string also can be set individually for all three communication ports.

Function	Value	Setting	Controlled by Commands
F7.0 Network Address	Id 0-9	0-9	Address for RS485 streaming output
F7.1 Com1 String	0-10	0-10	RS232-1 stream emulation. Default Anyload string,
F7.2 Com2 String	0-10	0-10	RS232-2 stream emulation. Default Anyload string
F7.2 Com3 String	0-10	0-10	RS485 stream emulation. Default Anyload string

Symbol	Description
	<p><b>NOTICE!</b></p> <p>To set the address of an indicator use F7 inside setup menu Refer to the troubleshooting diagnostic lights. Refer to the configuration section for more information on advance diagnostic</p>

## 7.5 SERIAL COMMANDS

The 815Ts indicators can receive remote commands via their dedicated serial ports.

Both RS232-1 and RS232-2 can be set receive serial commands. The serial commands can be useful to set certain functions of the indicator remotely.

The configuration of the com ports to receive serial commands can be configured in setup menu. The function is disabled as default and can be set using com port mode selection in setup menu.

Function	Value	Setting	Controlled by Commands
F5.2 Port1 Mode	3	<b>3</b>	RS232-1 mode selection 3 accept serial commands via RS232-1
F5.5 Port2 Mode	3	<b>3</b>	RS232-1 mode selection 3 accept serial commands via RS232-2

The remote commands set to be used are listed in below table.

Command	Description	Result
Z <CR>	Zero Command followed by CR	Same as ZERO key
T <CR>	Tare Command followed by CR	Same as TARE key
P <CR>	Print Command followed by CR	Same as PRINT key
U <CR>	Unit Command followed by CR	Same as UNIT key
? <CR>	Poll Weight Command followed by CR	Send out displayed weight via serial port
C <CR>	Clear Tare Command followed by CR	Same as CLEAR key
K <CR>	kg Unit Command followed by CR	Set the unit as kg
L <CR>	lb Unit Command followed by CR	Set the unit as lb
O <CR>	oz Unit Command followed by CR	Set the unit as oz
N <CR>	Net Command followed by CR	Same as GR/NT key
G <CR>	Gross Command followed by CR	Same as GR/NT key

Symbol	Description
	<p><b>NOTICE!</b></p> <p>Serial commands can be activated using F5 inside setup menu                      Refer to the troubleshooting diagnostic lights                      Refer to the configuration section for more information on advance diagnostic</p>

## 7.6 TICKET PRINTING

The 815TS can be used to print a simple ticket to print gross, tare, and net weight, with a time and date stamp.

One of the RS232-1, or RS232-2 can be set to print tickets based on the usage of comports.

Function	Value	Setting	Controlled by Commands
F5.2 Port1 Mode	2	2	RS232-1 mode selection 2 send out simple ticket with PRINT key
F5.5 Port2 Mode	2	2	RS232-1 mode selection 2 send out simple ticket with PRINT key

The simple ticket includes a time / date stamp. To activate and set proper format, clock can be activated inside setup menu.

Function	Value	Setting	Description
F9.0 Clock Setting	0	0	Clock Setting.
	1	1	It is disabled as default set to 0
	2	2	It activates Time / Date Stamps if none 0.
	3	3	If activated, set it using UNIT key long press in weight mode.
	4	4	0 It is disabled
			1 International/12hr format (dd/mm/yy) (HH:MMAM/PM)
			2 US/CAN/12hr format (mm/dd/yy)(HH:MMAM/PM)
			3 International/24hr format (dd/mm/yy) (HH:MM )
			4 US/CAN/24hr format (mm/dd/yy)(HH:MM)

The simple ticket format is as follows:

Title	Value	Description
Time:	12/24HR	Time stamp can be set to 12 or 24 hours formats
Date:	US/CAN/INT	Date can be set to US, CAN, or International formats
Gross:	000000	Prints gross weight with proper unit
Net:	000000	Prints net weight with proper unit
Tare:	000000	Prints tare value with proper unit

Symbol	Description
	<p><b>NOTICE!</b></p> <p>To set indicator in ticket printing format use F5 inside setup menu Refer to the troubleshooting diagnostic for error codes Refer to the configuration section for more information on advance diagnostic</p>

## 8. TROUBLESHOOTING

The 815TS indicators have comprehensive tools for troubleshooting, including diagnostic lights, onboard lights, error codes, message codes, and advance diagnostics inside setup menu. In cases where the failure or malfunctions is detected diagnostic tools can be used to identify the problems.

A 2032 type coin battery is located on board to keep the time and date. It is installed on a socket and is replaceable.

The position of the jumpers on the main board must be carefully observed and set.

The LEDs on the main board can be used as basic diagnostic for functionality of the indicator.

### 8.1 CONTROLLER BOARD

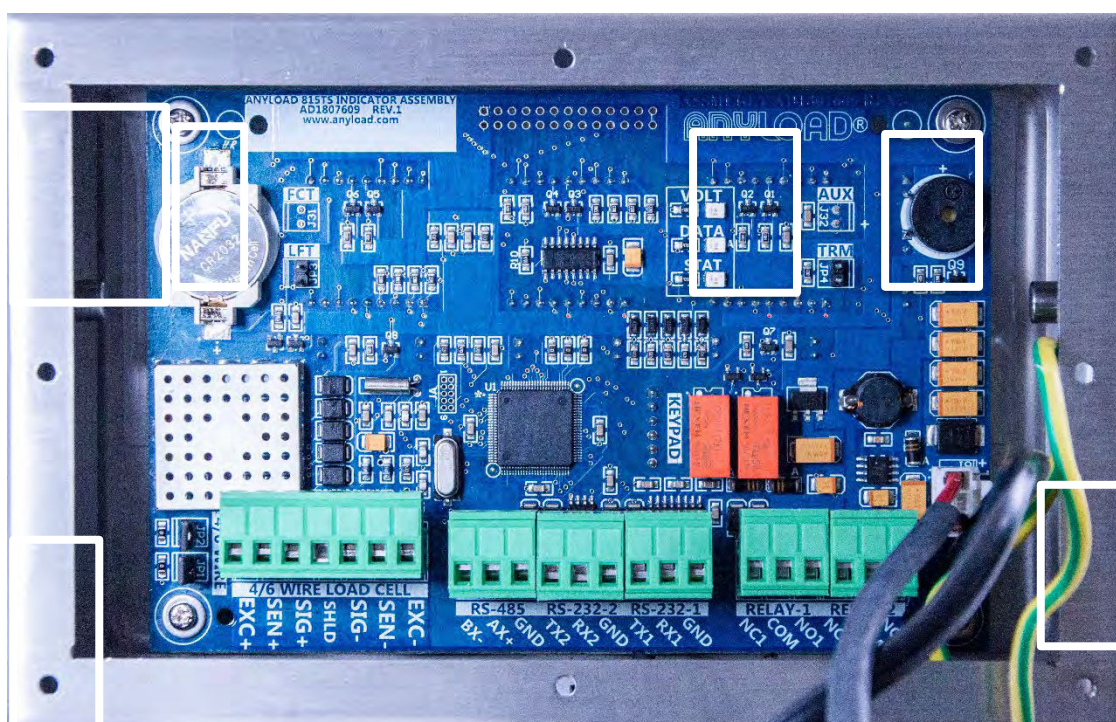

Symbol	Description
	<p><b>NOTICE!</b></p> <p>The battery is rated for a 2032 coin cell type                      Refer to the troubleshooting diagnostic lights and push buttons section for more information                      Refer to the configuration section for more information on advance diagnostic</p>

## 8.2 ERROR CODES

The 815TS indicators have a comprehensive error code messages to identify the issues, and to operate under guidelines of the regulatory bodies.

Error	Description	Reason
--E0--	Scale Overload	Capacity / Over Setting F1.7, and F1.8
--E1--	Can't Zero	Unstable / Zero Range Setting F2.0
--E2--	Can't Tare	Unstable / Tare Regulation Setting F2.6
--E3--	Can't Print	Unstable / Scale is Not Stable
--E4--	Can't Zero on Power Up	Unstable / Exceeds Zero Range
--E5--	Calibration Checksum Error	Set Factory Default / Call for Service
--E6--	Zero Checksum Error	Set Factory Default / Call for Service
--E7--	Can't Clear Tare	NTEP/CAN/OIML Tare Regulation F2.6
--E8--	Can't Display Weight	Out of Range Display / Scale Calibration
--E9--	Can't Display Count	Out of Range Counts / Scale Calibration

## 8.3 JUMPER SETTING

The 815TS have few jumper headers on the main board. They are to be set accordingly.

Label	Description	Reason
FCT	Do Not Jumper	Closing this may damage main board
LFT	Non-Legal for Trade	Closing this will bypass setup password
AUX	Do Not Jumper	Closing this may damage main board
TRM	RS485 Termination	Close this for long distance RS485 networks
4/6 WIRE1	4/6 Wire Load Cells	Close this for 4 wire load cells with no sense line
4/6 WIRE2	4/6 Wire Load Cells	Close this for 4 wire Load cells with no sense line

Symbol	Description
	<p><b>NOTICE!</b></p> <p>LFT jumper must be open for Legal for Trade applications                      Do Not jumper any of AUX or FCT, as may cause damage to the device                      4/6 Wire jumpers are closed as default for both 4 or 6 wire load cells</p>

### 8.4 DIAGNOSTIC LIGHTS

The diagnostic lights are located on the main board for basic troubleshooting.

LED	Normal	Failure
VOLT	If ON, 12V voltage is present. Power is normal.	If OFF, 12V display voltage has failed. Check the power supply
DATA	Flashing. Data is streaming via RS232-1	Solid OFF. Serial port is off.
STAT	Blinking every ½ seconds. Normal operation of the indicator	Solid OFF or ON. Main board failure.

### 8.5 ADVANCE DIAGNOSTIC

The diagnostic section of the inside menu is used for display testing and clock setting.

Function	Value	Setting	Description
F9.0 Clock Setting	0 1 2 3 4	0 1 2 3 4	Clock Setting. It is disabled as default set to 0. It activates Time / Date Stamps if not 0. If activated, set it using UNIT long press in weight mode.  0 It is disabled. 1 International/12hr format (dd/mm/yy) (HH:MMAM/PM) 2 US/CAN/12hr format (mm/dd/yy)(HH:MMAM/PM) 3 International/24hr format (dd/mm/yy) (HH:MM ) 4 US/CAN/24hr format (mm/dd/yy)(HH:MM)
F9.1 Display Test	XXXXXX	None	Runs a full display test

In normal weight mode, use  long press key to edit the time / date in CLOCK mode.

Symbol	Description
	<p><b>NOTICE!</b></p> <p>The battery is rated for a 2032 coin cell type for clock                      The clock is used to ticket stamps if activated                      The clock can be edited in weight mode using UNIT long press if is activate</p>



Please Contact our Authorized Dealer for Technical Assistance:

## Anyload Weigh & Measure Inc.

North America Toll Free: 1-855-ANYLOAD (269-5623)

Email: [info@anyload.com](mailto:info@anyload.com)

[www.anyload.com](http://www.anyload.com)

