



1-855-269-5623
www.anyload.com

PN-250802-C

© ANYLOAD Weigh & Measure Inc. All rights reserved.

ANYLOAD® is a registered trademark of ANYLOAD Weigh & Measure Inc.

All other brand or product names mentioned in this document are trademarks or registered trademarks of their respective owners.

All information contained in this document is, to the best of our knowledge, complete and accurate at the time of publication. ANYLOAD Weigh & Measure Inc. reserves the right to make changes to the technology, features, specifications, and design of its equipment without prior notice.

The most current version of this document, along with any software, firmware, and other product updates, can be found on our website:

www.anyload.com

Legal Notice

ANYLOAD products are subject to our **Standard Terms and Conditions of Sale, Warranty Policy**, and applicable regulatory compliance requirements as they may be updated without notice. It is the user's responsibility to ensure proper installation, operation, and maintenance of the equipment as outlined in this manual and in accordance with all relevant laws and standards.

ANYLOAD Weigh & Measure Inc. disclaims all warranties not expressly stated in the Warranty Policy, including but not limited to implied warranties of merchantability and fitness for a particular purpose. ANYLOAD shall not be liable for any direct, indirect, incidental, or consequential damages arising from the use or inability to use this equipment.

CONTENTS

- 1. Introduction 3
 - 1.1 Safety..... 3
- 2. Description..... 5
 - 2.1 Plate..... 5
 - 2.2 Display and keys 6
 - 2.3 Battery Charge 6
- 3. Installation 7
 - 3.1 Sequential Weighing 7
 - 3.2 WIM (Weigh In Motion) 8
 - 3.3 Synchronous Weighing 9
- 4. Settings..... 10
- 5. Test modes..... 11
- 6. Check Messages 11
- 7. Specifications..... 12
 - 7.1 General 12
 - 7.2 Wireless..... 12
 - 7.3 Dimensions..... 13

Revision History:

Record with brief description of all revisions made to product or manual

Version	Date	Description
1.0.0	August 19th, 2025	First public release version.

The most current version of this document, along with any software, firmware, and other product updates, can be found on our website:

www.anyload.com

1. Introduction

This manual provides information on installation, configuration, calibration and servicing of the AXA [Category].

For questions regarding this manual or the operation of ANYLOAD products, please contact your authorized ANYLOAD distributor or visit our website at www.anyload.com for support resources and service information.

1.1 Safety

READ this manual BEFORE operating or servicing this equipment or systems with this equipment incorporated.





FOLLOW these instructions carefully.

DO NOT allow untrained personnel to operate, clean, inspect, maintain, service, or modify this equipment.

SAVE and distribute this manual for future reference.

Failure to follow the instructions or heed the warnings could result in injury or death. Contact any ANYLOAD dealer or distributor for replacement manuals.

Indicative Markings:

Symbol	Significance
 WARNING 	Warns of a potentially dangerous situation which can result in serious physical injury or death
 CAUTION	Warns of a potentially dangerous situation which can result in slight or moderate physical injury
Notice	Failure to comply to information with this marking may lead to damage to property
 Important	Important information about the product
 Tip	Application tips and other information that may be helpful
<i>For emphasis (Italics)</i>	Italics are used to emphasize key information

General Safety:

WARNING

ONLY qualified professionals approved should carry out intrinsically safe installations. This work involves extensive knowledge of the product, specific safety standards, and the potentially hazardous environment in which it will

- Do not allow minors or inexperienced individuals to operate this unit.
- Ensure the unit is fully assembled before operation.
- Keep hands and fingers away from slots, openings, or any potential pinch points.
- Do not use this product if any component appears cracked or damaged.
- Avoid making alterations or modifications to the unit.
- Do not remove or obscure any warning labels.
- Do not submerge the unit in water.
- Before opening the unit, ensure the power cord is disconnected from the power source. Disconnect all power sources before servicing, as multiple power sources may be present. Failure to do so may result in property damage, personal injury, or death.
- For permanently connected equipment, incorporate a readily accessible disconnect device in the building's installation wiring.

- Pluggable units must be installed near an easily accessible socket/outlet.
- Use only copper or copper-clad aluminum conductors when wiring.

Recommendations for Proper Use:

- Keep the instrument away from heat sources and direct sunlight.
- Protect the instrument from rain unless it is a special IP-rated version.
- Do not clean with water jets unless specified for IP-rated models.
- Avoid dipping the instrument in water or spilling liquids on it.
- Use a soft, dry cloth for cleaning; do not use solvents or abrasive materials.
- Do not install the unit in areas with explosion hazards unless with specially rated models.
- If the working environment reaches the unit’s temperature limits, ensure proper airflow around the instrument to prevent malfunctions such as sudden shutdowns or disconnections.
- Use only approved enhancements and batteries. Do not connect incompatible products. Use only batteries, chargers, adaptor, and enhancements approved by vendor for use with this particular model. The use of any other types may invalidate any approval or warranty, and may be dangerous. For availability of approved enhancements, please check with your dealer.
- Do not use the product in a place with a high-voltage current or severe electronic noise.
- Do not use the product in a place with severe vibration.
- Do not put too much pressure to keys.

Disposal Guidelines:



Product Disposal: Dispose of this product at authorized waste collection centers at the end of its life cycle. Proper disposal prevents environmental and health risks and supports recycling. Illegal disposal may result in legal penalties.

Battery Disposal: Dispose of batteries at designated centers as per local laws. Batteries may contain harmful substances (e.g., Cd, Li, Hg, Pb) and must not be discarded with household waste. Improper disposal may result in legal penalties.

⚠ WARNING ⚠

Be cautious of below situations, when placing the product on the road.

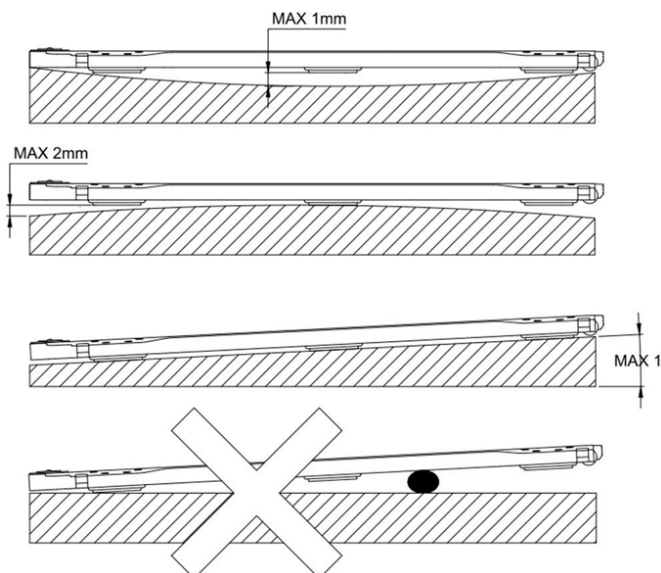

2. Description

2.1 Plate

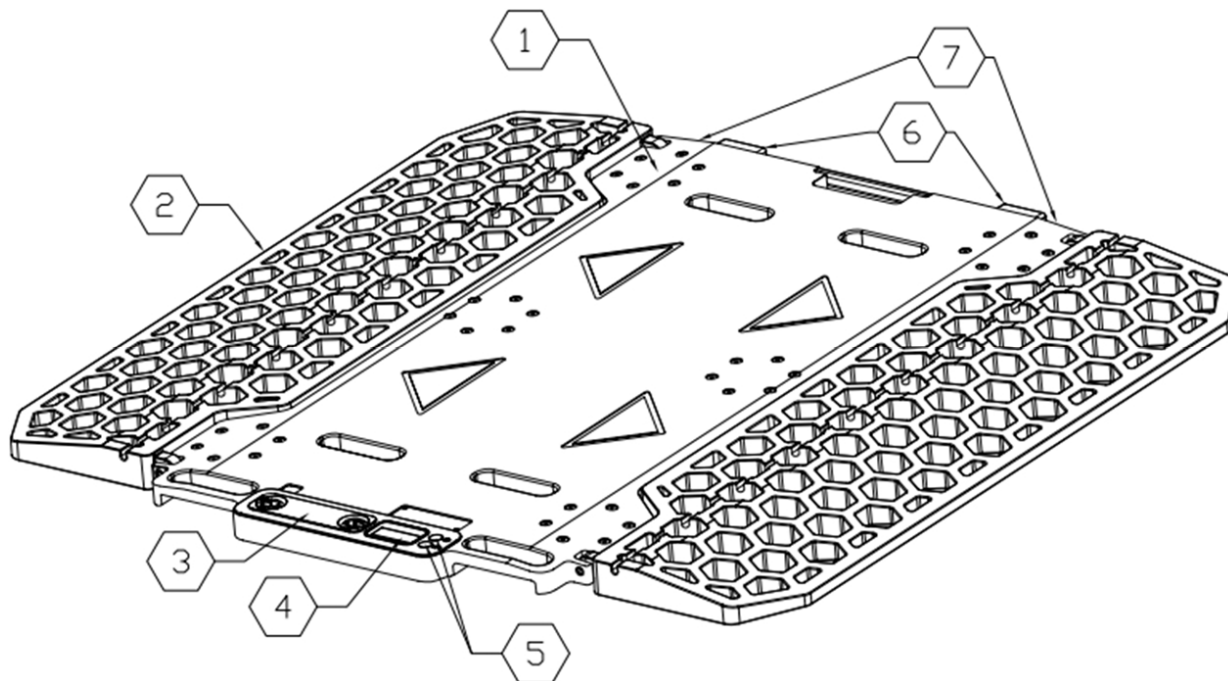

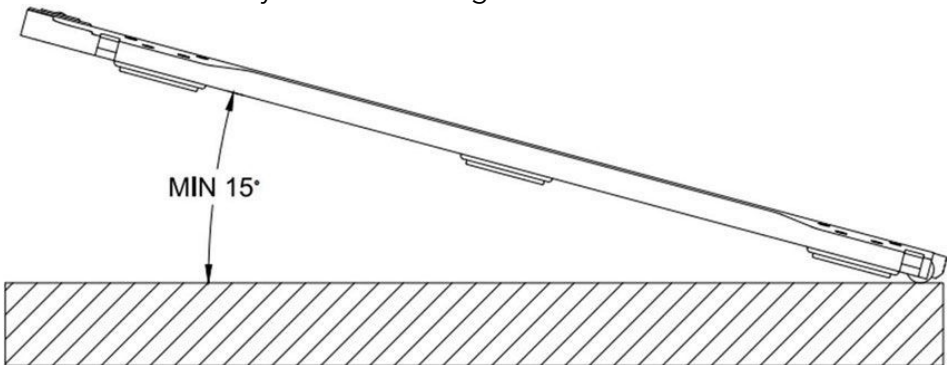
No	Name	Functions
1	Load cell	Integrated with six load cells for accurate weight measurement.
2	Ramps	Urethane ramps designed for smooth vehicle entry.
3	Battery cover	Waterproof enclosure that protects the internal battery.
4	LCD display	Shows weight readings and system messages.
5	Touch switch	Capacitive touch controls for power and zeroing functions.
6	Stand rubber	Provides support when placing the product in an upright position.
7	Wheels	<p>Mounted on the bottom for transportation.</p> <p>⚠ CAUTION</p> <p>When moving the product, tilt it at minimum of 15 degrees, as shown below. Failure to do so may result in damage to the load cell covers.</p>  <p>The diagram shows the plate tilted at an angle of at least 15 degrees relative to a horizontal surface. An arrow points to the angle with the text 'MIN 15°'.</p>

2.2 Display and keys

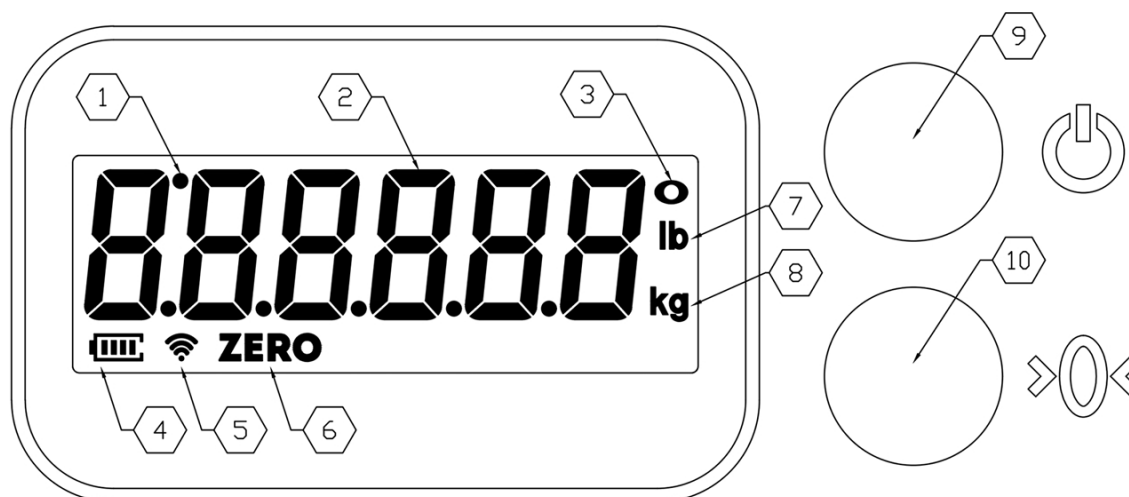

No	Functions
1	Blinks to indicate that device is in WIM (Weigh-In-Motion) mode
2	Shows the current measured weight value
3	Indicates when a stable measurement has been achieved
4	Displays the remaining battery capacity
5	Displays signal strength for wireless connectivity (applicable to wireless models)
6	Appears when the measured value is 0
7	Indicates that the unit of measurement is in pounds
8	Indicates that the unit of measurement is in kilograms
9	Touch-sensitive control for turning the device on or off - Touch the power switch 3 times in a row to power on or off
10	Multi-function switch, - Touch the switch 3 times in a row, - - - is displayed and resets to 0 - Touch the switch 3 times in a row, - - - - - is displayed and the backlight turns on or off.

2.3 Battery Charge

- Indicates the remaining capacity of the battery
- If the battery icon is , charge the battery immediately
 - ① **Tip** When low battery, the status is displayed in the indicator.
- Charging method:
 - 1) Turn clamps that exit on both sides of battery cover to the left by a quarter.
 - 2) Be sure to charge by supplied battery charger.
 - Charge terminal is USB-C. You can charge by USB-A port of PC, laptop and power adapter.
 - 3) The red lamp turns on when it is charging. When charging is completed, the lamp goes green.
 - ① **Tip** The estimated time for charging is about 5 hours but charging time can be varied according to environment conditions.
 - (4) Inserting is in reverse.

CAUTION

Do not connect to reverse battery polarity. Battery should only be replaced in a non-hazardous area using the battery types specified in this manual.

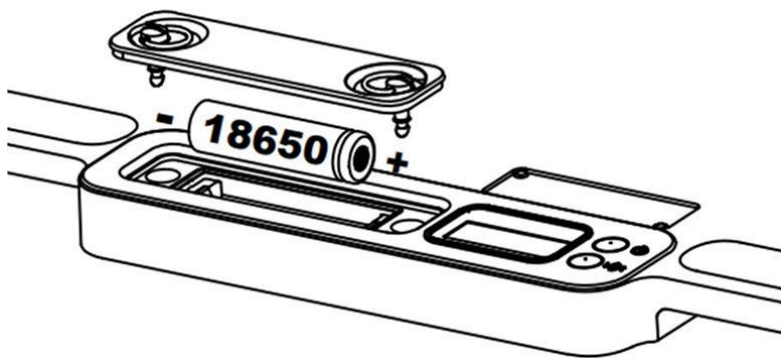

3. Installation

3.1 Sequential Weighing

- Configuration: 2 plates / 1 indicator
- Method: After weighing axles one by one, calculate the total weight of the vehicle by summing up the weight of each axle
- Mode: Static mode or WIM (Weigh-In-Motion) mode.
- Accuracy: $\pm 0.1 \sim 0.3\%$ (WIM: $\pm 1 \sim 3\%$)
- Installation: Install the plate 1 on the left side of driving direction and install the plate 2 on the right side.

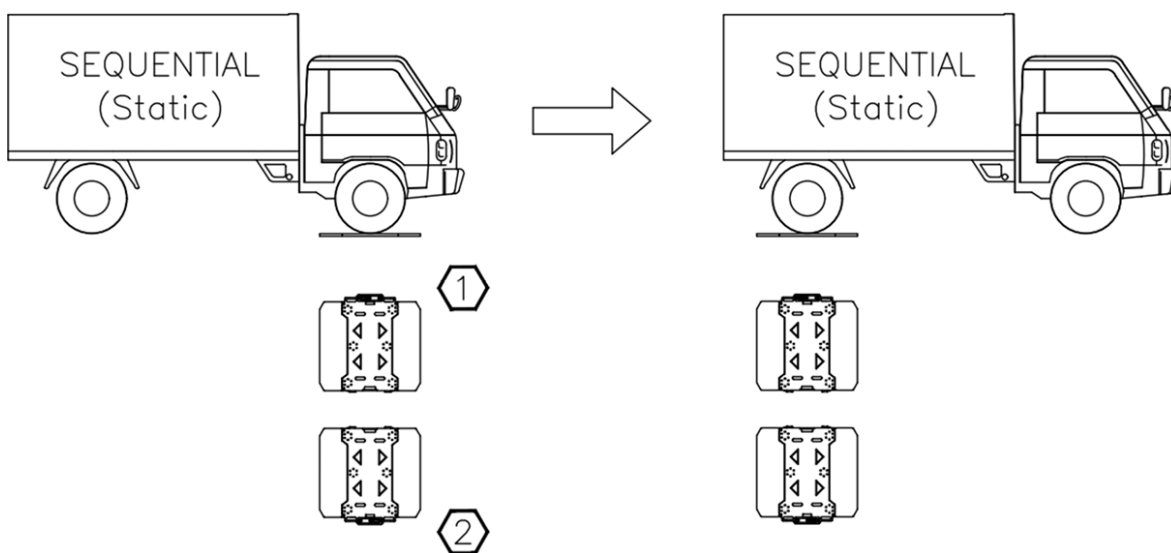

⚠ CAUTION

As shown below, if inter axle distance is short, you must install sufficient extension pads.

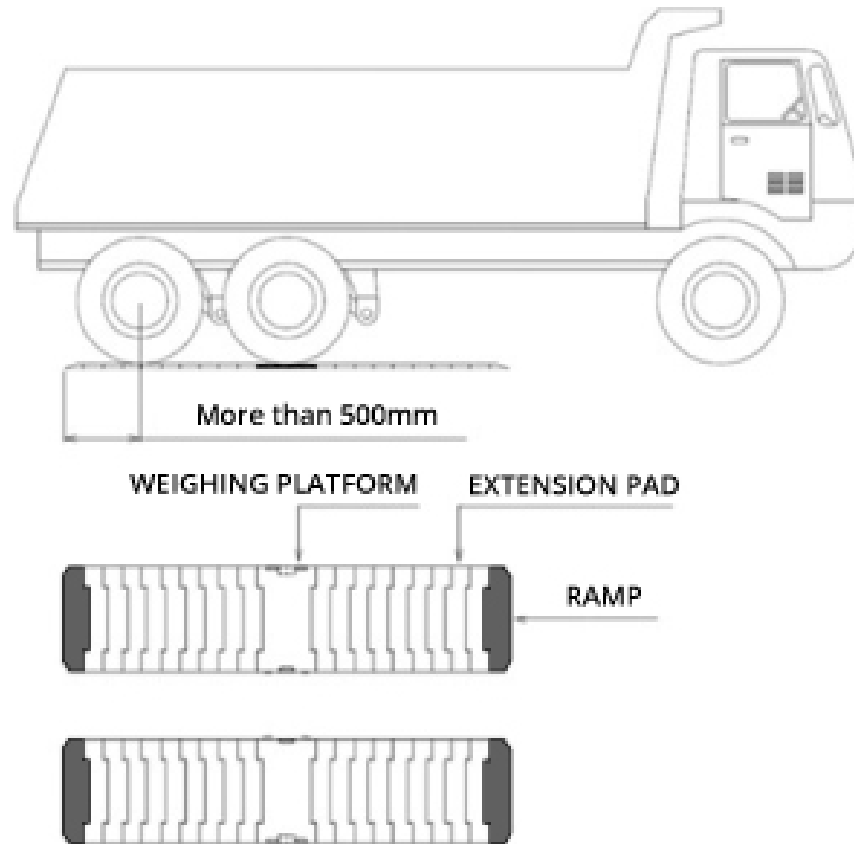

⚠ CAUTION

3.2 WIM (Weigh In Motion)

- Configuration: 2 plates / 1 indicator
- Method: After weighing axles one by one, calculate the total weight of the vehicle by summing up the weight of each axle
- Accuracy: WIM: $\pm 1\sim 3\%$
- Installation: Install the plate 1 on the left side of driving direction and install the plate 2 on the right side.

In order to use WIM mode, the 'AXA-8-EXT-30' extension pad must be purchased separately.

- Each box contains 30 pieces.
- A total of 45 pieces per side are required (90 pieces in total).
- Therefore, 3 boxes must be purchased.

- The third box will be split evenly, with 15 pieces used on each side.

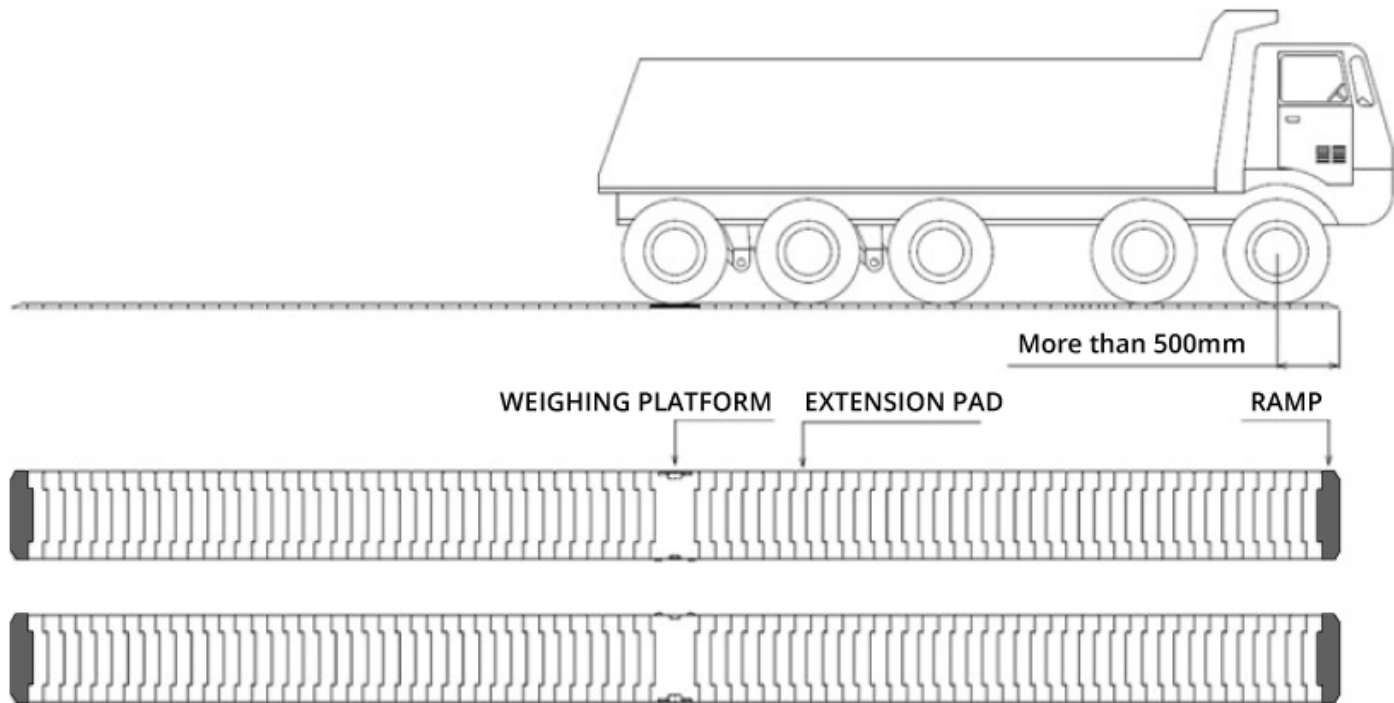

3.3 Synchronous Weighing

- Configuration: The number of plates equal to the number of wheel / 1 indicator
- Method: Measure all axles at the same time
- Mode: Synchronous mode
- Accuracy: $\pm 0.1\%$
- Installation: Install the plate 1 on the left side of driving direction and install the plate 2 on the right side. You can install the plates for other axles in the same way.

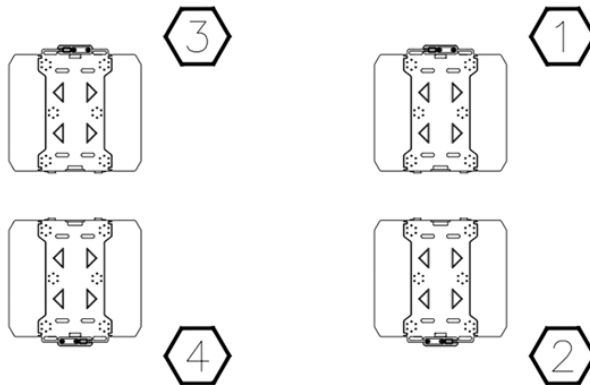
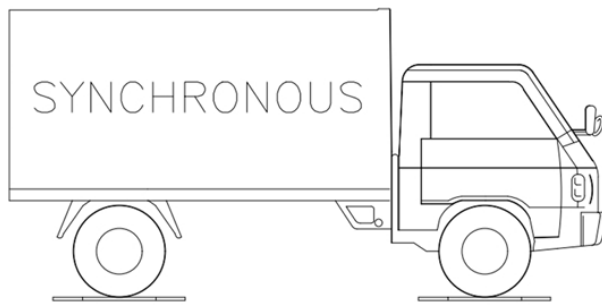

4. Settings



How to enter	<p>After powering on, touch the power key for 2 seconds and SEt will be displayed. At this time, if you release the power key, the setting mode starts.</p> <div style="border: 1px solid black; padding: 5px; display: inline-block;"> <p>on --- F= 100 touch the power switch for 2 seconds SEt</p> </div>
Used keys	<p>POWER: Used to increase the setting constant one by one. ZERO: Used to move to next menu after completing input value.</p>
F01-0	<p>Automatic power off (range: 0, 1 / default: 0) When the wireless communication with the indicator is lost, power is turned off automatically after 70 seconds. (0: Not used, 1: Used)</p>
F02-2	<p>Automatic zero condition (range: 0~9 / default: 2) This function will automatically bring the display back to zero when there are small deviations.</p> <p>For example: F02-1 setting Display will automatically zero at less than 1 digit per 0.5 second. Diagram shown below.</p> <div style="text-align: center;"> </div>
F03-6	<p>Brightness of the backlight (range: 0~9 / default: 6) Adjust the backlighting brightness. (10%~100%)</p>
F04-0	<p>Weighing unit (range: 0, 1 / default: 0) 0: kg 1: lb</p>
F05-0	<p>Weight backup function (range: 0, 1 / default: 0) When enabled, the weight value is displayed if there are any weighing objects when the power is turned on.</p>

	0: OFF 1: ON
F06 - 1	Wireless function (range: 0, 1 / default: 1) 0: OFF 1: ON

Tip

- After changing the settings values, you must confirm the last menu(F06) and exit the mode.
- To turn off the product in setting mode, press the power switch for 2 seconds.

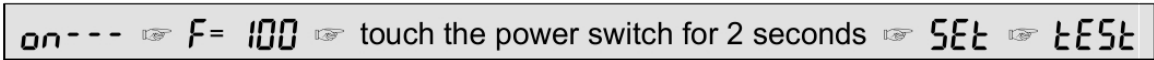
5. Test modes

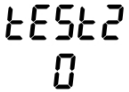
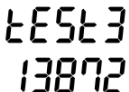
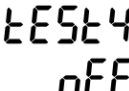
How to enter	After turning on the product, when the version is displayed, touch the power switch for 4 seconds and SEt is displayed, and then tEst displayed. At this time, if you release the power switch, the test mode starts. 
Used keys	POWER: Used to test equipment. ZERO: Used to move next menu.
	Display test It operates automatically and the whole display is ON.
	Key test Touch a key that you want to test, and then the display message will be shown. (POWER: 1 / ZERO: 2)
	Load cell test Displays the A/D (analog-to-digital) conversion constant. This value may vary depending on the equipment. To verify proper function, apply force to the scale and confirm that the displayed value changes accordingly. If the value does not change, remains at '0', or displays a check message, immediately contact your dealer for service.
	Backlight test Touch the power switch to turn on(off) the backlight. Touch the zero switch to exit test mode.

Tip To turn off the product in test mode, press the power switch for 2 seconds.

6. Check Messages

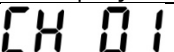
Display	Description
	Error in the load cell connection or in the A/D convertor.

	Please check the load cell and then contact dealer to resolve this technical problem.
CH 02	The current weight is out of range for zero point. Zero key is operated within 50% of maximum capacity.
ouEr	The gross weight is over maximum capacity. Don't load the article whose weight is heavier than the maximum capacity.

7. Specifications

7.1 General

MODEL	AXA-3			AXA-5		AXA-8		
CAPACITY (tons)	0.5	1	2	3	5	10	15	20
DIVISION (kg)	0.2	0.5	1	1	2	10	10	20
DISPLAY	5-digit FSTN LCD & LED Backlight							
OPERATING SWITCH	2 Capacitance touch switches							
RAMP/PAD MATERIAL	Urethane							
FRONT COVER MATERIAL	Polycarbonate							
BODY MATERIAL	Aluminum, Hammer-tone powder coating							
WIRELESS METHOD	Zigbee							
INGRESS PROTECTION	IP68							
BATTERY	Rechargeable 18650 Li-ion with PCM							
CHARGER	Exclusive battery charger							
OPERATING TIME	600hrs							
OPERATING TEMP.	-20°C ~ 60°C							
OPERATING HUMIDITY	85% R.H. (No condensation)							
PRODUCT WEIGHT (APPROX.)	5.8 kg / 12.8 lbs			16 kg / 35 lbs		19 kg / 42 lbs		
	Ramp included in weight					Ramp not included		

7.2 Wireless

PROTOCOL	802.15.4
INTERFERENCE IMMUNITY	DSSS (Direct Sequence Spread Spectrum)
ENCRYPTION	128-bit AES
RELIABLE PACKET DELIVERY	Retries/Acknowledgements
IDS	PAN ID and addresses, cluster IDs and endpoints (optional)
CONFIGURATION METHOD	API or AT commands, local or over-the-air (OTA)
CHANNEL	16 channels
FREQUENCY BAND	ISM 2.4GHz
ITU DESIGNATION	2M97G1D
MAXIMUM OUTPUT POWER	6.3mW / (+8dBm)
INDOOR/URBAN RANGE	30m international variant
OUTDOOR RF LINE-OF SIGHT	100m international variant
RF DATA RATE	250,000bps, Serial up to 1Mbps
RECEIVER SENSITIVITY	-102dBm (1% packet error rate)
SUPPLY VOLTAGE	2.1 ~ 3.6VDC

Please Contact Our Authorized Dealer for Technical Assistance:

Empty rectangular box for technical assistance contact information.

Notes:

V1.0.0
PN-250802-C

1-855-269-5623
www.anyload.com

